

EFV1-12-C - Proportional Valve

Proportional flow, normally closed spool

Up to 77 L/min (20.6 USgpm) • 210 bar (3000 psi)

B

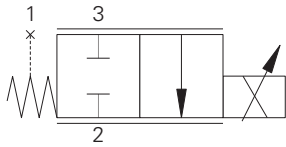

Sectional View

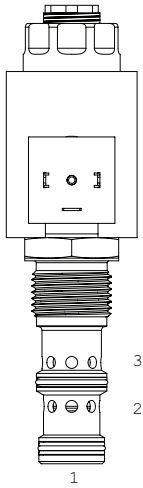

Description

This is a 2 way 2 position, pilot operated spool type, normally closed, proportional flow control screw in cartridge valve. Ideal for speed control and in conjunction with pressure compensators to provide proportional pressure compensated flow control to any actuator.

Operation

The valve is controlled by current supplied to the coil. At zero current, the valve is fully closed from port 3 to port 2. At 1500 mA (12V coil) the valve is considered fully open. This is the maximum intended current level for use in applications. Port 1 is used for pressure balancing the spool and armature and must be blocked in all cases. The maximum intended pressure drop is 300 PSID. At pressure drops above 300 PSID, almost no increase in flow is obtained. The intended flow direction is from port 3 to port 2.

Operation of the valve with flow from port 2 to port 3 will produce flow vs current and flow vs pressure drop curves that are significantly different from those obtained with flow from port 3 to port 2. Since the spool and armature are pressure balanced, the operating pressure does not affect the operating characteristics of the valve. The operating point of the valve is determined only by current, pressure drop and temperature.

Features

Hardened and ground working parts to give long life with good control; Compact design with low pressure drop. IP69K Tough coil compatibility, continuously rated.

Performance Data

Ratings and Specifications

Performance data is typical with fluid at 21,8 cST (105 SUS) and 49°C (120°F)

Typical application pressure	210 bar (3000 psi)
Cartridge endurance rating	1 million cycles
Cartridge fatigue pressure (infinite life)	210 bar (3000 psi) NFPA rated
Rated flow	Flow rating "A" 55 L/min (14.3 USgpm) Flow rating "B" 77 L/min (20.6 USgpm)
Internal leakage (fully closed)	77-483 cm ³ /min (5-30 in ³ /min) @ 210 bar (3000 PSID)
Nominal supply voltage	12/24 V
Current to fully close valve	1500-1600 mA (12V coil), 750-800 mA (24V coil)
Recommended dither frequency	200-400 Hz
Coil resistance	4.7v /12V, 19.0 /24V
Mass	Cartridge only 0,37 kg (0.82 lb), cartridge with coil and end nut 0,73 kg (1.62 lb)
Temperature range	-30° to 90°C (-22° to 194°F)
Maximum oil temperature	120°C (248°F)
Maximum internal coil temperature	200°C (392°F)
Cavity	C-12-3
Fluids	All general purpose hydraulics fluids such as: MIL-H-5606, SAE 10, SAE 20, DTE 24, etc.
Filtration	Cleanliness code 18/16/13
Housing material (standard)	Aluminum or steel
Hysteresis	1 USgpm with 400Hz PWM driver
Seal kit	9900171-000 (Buna-N), 9900172-000 (Viton)

Viton is a registered trademark of E.I. DuPont

EFV1-12-C - Proportional Valve

Proportional flow, normally closed spool
Up to 77 L/min (20.6 USgpm) • 210 bar (3000 psi)

Pressure Drop Curves

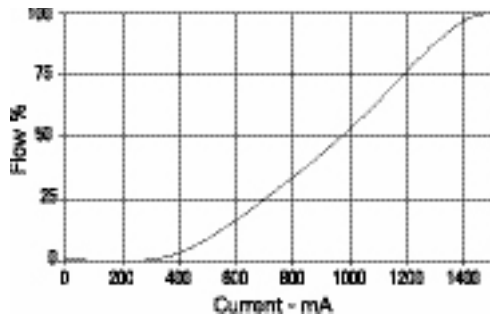
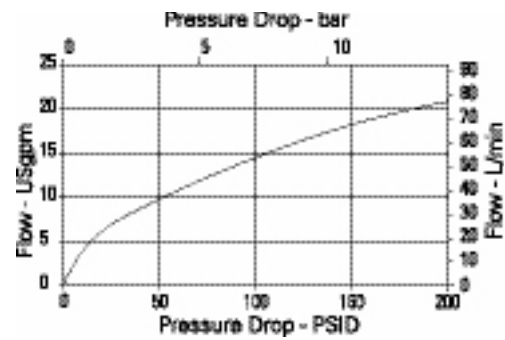
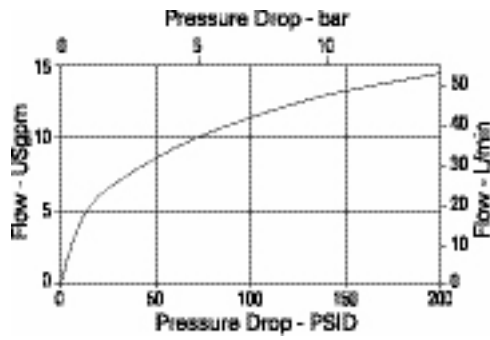

Note: To determine operating characteristics for the flow rating selected, at a specific differential pressure, first determine maximum flow from upper curve at the differential pressure value. This will be the "100%" flow on the lower curve.

Parameters:
400 Hz PWM

EFV1-12-C - Proportional Valve

Proportional flow, normally closed spool

Up to 77 L/min (20.6 USgpm) • 210 bar (3000 psi)

B

Model Code

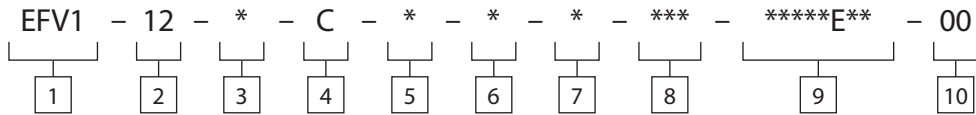

1 Function
EFV1 - Electro proportional flow control valve

2 Size
12 - 12 size

3 Seal Material
N - Buna-N
V - Viton®

4 Logic
C - Normally closed

5 Flow Rating
A - 14.3 USgpm @ 300 PSID
B - 20.6 USgpm @ 300 PSID

6 Manual Override Option
0 - No core tube special features
S - Screw-in

8 Port Size

Code	Port Size	Housing Number	
		Aluminium Single	Steel Single
0	Cartridge only		
4G	1/2" BSPP	02-161817	02-169815
6G	3/4" BSPP	02-161816	02-169814
10T	SAE 10	02-160642	02-161070
12T	SAE 12	02-160646	02-169816

Note: Both the manifold and port plug are required.
See section J for housing details.

7 Valve Housing Material
Blank - Cartridge only
A - Aluminum
S - Steel

9 Coil Series
E - E series coils
*These model digits will not be stamped on the valve.

For coil part numbers and dimensions see section C.

10 Special Features
00 - None
Only required when valve has special features, omitted if "00".

EFV1-12-C - Proportional Valve

Proportional flow, normally closed spool
Up to 77 L/min (20.6 USgpm) • 210 bar (3000 psi)

Dimensions

mm (inch)

Torque cartridge in steel housing

S - 136-149 Nm (100-110 ft lbs)

A - 108-122 Nm (80-90 ft lbs)

Note:

Port 1 is unused and must be plugged.

Note:

EFV1-12 with DIN-43650 connector shown.

Cartridge Only

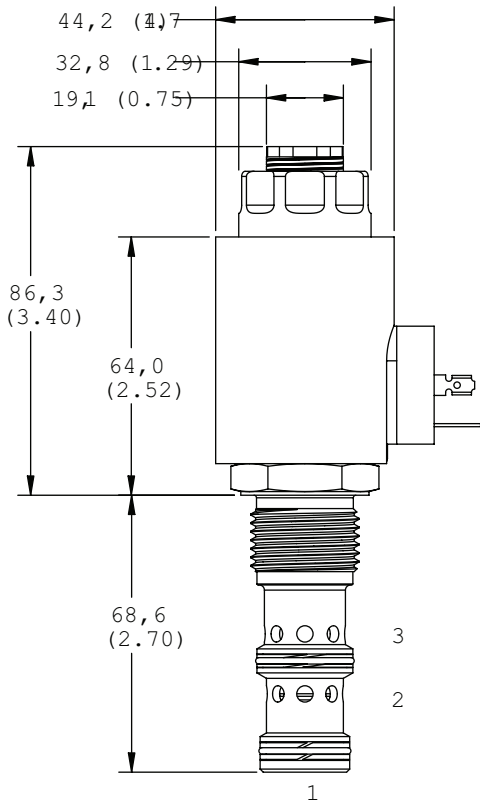

Installation Drawing (Aluminum)

